

## 1T7070 | OZ Recessed profile

### Recessed profile for 50x50mm light modules

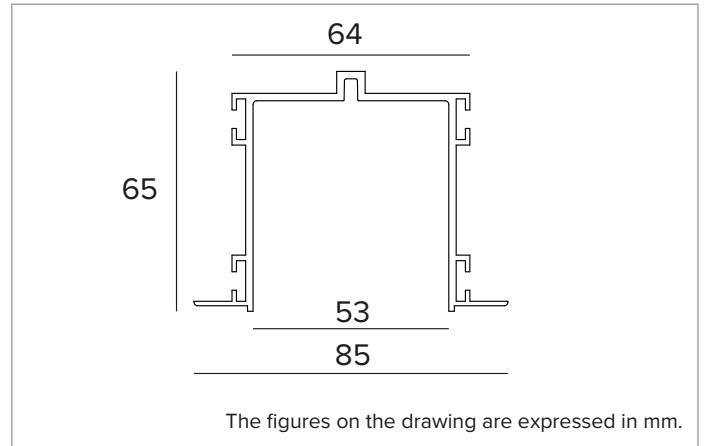
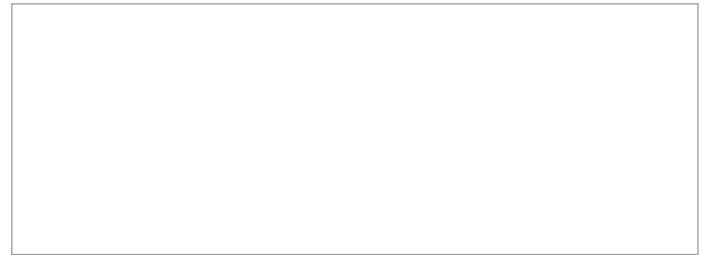
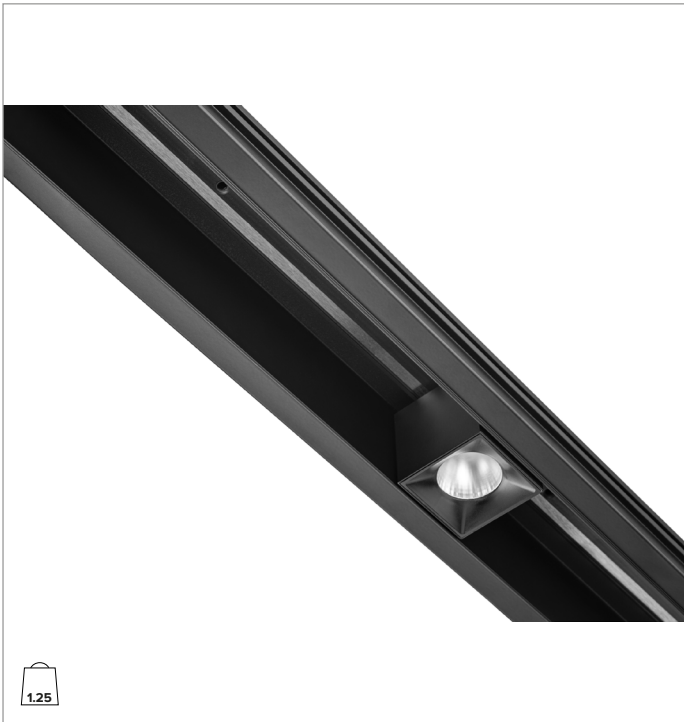

#### MECHANICAL CHARACTERISTICS

Extruded painted aluminium profile.

**Colour and finish:** Deep black

**Dimensions:** L=1000mm

**Weight:** 1.25Kg

**Version:** FOR 50x50mm LIGHT MODULES

#### INSTALLATION

For trimless installation or with a flange.

#### NOTES

To be completed with Power Track.

#### WARRANTY

5 years.

#### WARNING

Luminaire designed for disposal/recycling at end-of-life.

*Due to the technological evolution of the electronic components, the data provided may be updated, and as such, confirmation must be requested during the order process.*

*Luminous flux and power supply have +/-10% tolerances with respect to the indicated value. tq +25°C (CIE 121).*

*We reserve the right to make technical changes.*

Targetti Sankey S.r.l.  
Via Pratese, 164  
50145 Firenze - Italy  
Tel: +39 055 37911  
targetti.com  
targetti@targetti.com

CCIAA Firenze  
Share Capital:  
€ 500.000,00  
VAT N. (IT):  
01537660480  
R.E.A: FI-275656

**TARGETTI**

## 1T7070 | OZ Recessed profile

### Recessed profile for 50x50mm light modules

#### Related codes

##### Mounting System

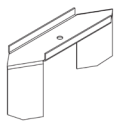

Code

**1T7076**

Steel bracket for recessed installation of the large profile.  
2 pieces to be ordered for 1m long modules, 3 pieces for 2m long modules and 4 pieces for 3m long modules.

##### End Caps

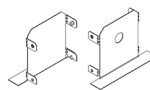

Colour

Code

**1T7074**

Kit containing 2 profile end caps.  
For large recessed profiles.

#### Accessories

##### Mechanical connector

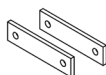

Code

**1T7041**

Kit composed of 2 mechanical linear joints and 4 thrust screws.  
For trimless installation profile.

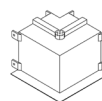

Colour

Code

**1T7438**

Mechanical L connector.  
For large recessed profiles.

Due to the technological evolution of the electronic components, the data provided may be updated, and as such, confirmation must be requested during the order process.

Luminous flux and power supply have +/-10% tolerances with respect to the indicated value. tq +25°C (CIE 121).

We reserve the right to make technical changes.

Targetti Sankey S.r.l.  
Via Pratese, 164  
50145 Firenze - Italy  
Tel: +39 055 37911  
targetti.com  
targetti@targetti.com

CCIAA Firenze  
Share Capital:  
€ 500.000,00  
VAT N. (IT):  
01537660480  
R.E.A: FI-275656

# TARGETTI